



Microelectrode AC Amplifier

1800

INSTRUCTION MANUAL

FOR

MICROELECTRODE AC AMPLIFIER

MODEL 1800

Serial # _____

Date _____

A-M Systems, Inc.

PO Box 850

Carlsborg, WA 98324

U.S.A.

360-683-8300 ♦ 800-426-1306 FAX:

360-683-3525

<http://www.a-msystems.com>

Version 13.0

March 2020

Contents

General Description	1
Instrument Features	1
Controls and Connector	2
Operating Instructions	4
Typical Set-Up Procedure	4
Problem Solving.....	6
Theory of Operation	9
Specifications	8
Warranty and Service	9

***Each Microelectrode Amplifier
is delivered complete with:***

***Two Head Stage with 5 Foot Cables
Six 4 Inch Electrode Connector Cables
Rack Mount Hardware***

NOTE

This instrument is not intended for clinical measurements using human subjects. A-M Systems, Inc. does not assume responsibility for injury or damage due to the misuse of this instrument.

General Description

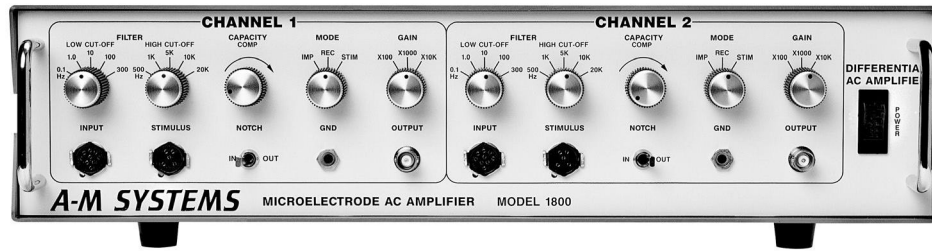

Instrument Features

The *AC Microelectrode Amplifier Model 1800* is a two-channel, differential amplifier with headstage probes. The instrument is intended for extracellular recording and/or stimulating in conjunction with high impedance metal microelectrodes. It can be used in a number of research or teaching applications requiring extracellular neurophysiological recording from excitable tissue, such as nerve, muscle (EMG), EEG, EKG, and ERG recordings. **The instrument is not intended for clinical measurements using humans.**



Each channel of the *Model 1800* contains a high-gain, low-noise differential amplifier stage followed by low frequency, high-frequency, and notch filters. Three operating modes are available to accommodate recording, stimulating, and verification of electrode impedance. Record Mode offers three levels of signal gain (x100, x1000, x10 000). Stimulus Mode allows the current passing through the electrode to be measured during stimulation. Impedance Mode utilizes an internally calibrated current source to allow in situ verification of electrode impedance.

Controls and Connectors

INPUT: This 9-pin connector receives the signal from the Headstage Probe for further processing.

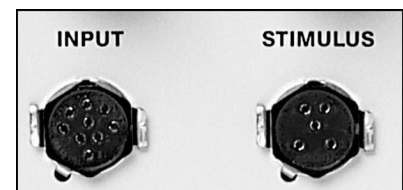

STIMULUS: This 5-pin connector enables an isolated stimulus source to be utilized to pass current through the electrode while the channel is in Stimulate Mode. The pin assignments are listed in the following table.

Pin	Location	Signal
A	upper left	+
B	upper right	-
H	middle	ground

three wires that will connect these sockets to standard electrode pins. **SIGNAL+** (the largest jack.. it accepts a 2mm pin) is used to connect to the electrode (usually an high impedance metal electrode). **REFERENCE-** is used to connect to the indifferent lead. Either the **PROBE GROUND** connector or the front panel **GROUND** must be connected for proper operation. Usually the **PROBE GROUND** connector is tied to the indifferent lead. If you desire to have the current constrained to a known path you may want to place the **GROUND** elsewhere. Actual **GROUND** placement depends on the application.

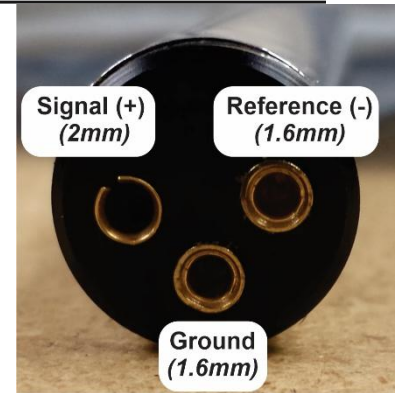

MODE: This rotary switch controls the operating mode for its channel. The switch allows the user to select Record Mode (**REC**) Stimulate Mode (**STIM**), or Impedance Check Mode (**IMP**).

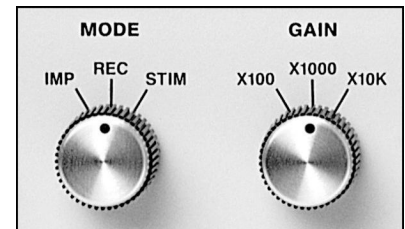

GAIN: This rotary switch controls the level of signal gain for its channel while the channel is in Record Mode. The switch allows the user to select from **X100**, **X1000**, or **X10000** gain. This switch has no effect in Stimulate Mode and Impedance Check Mode.

CAPACITY COMP: This knob provides control over the amount of capacitance in parallel with the electrode while the channel is in Impedance Check Mode. Turning this knob clockwise decreases the level of capacitance. With the electrode capacitance reduced, the measured impedance will largely be a measure of the resistive component of the electrode. *Warning: Turning the Capacity Compensation too high will cause the circuit to oscillate wildly and change frequency, and may also cause the electrode to behave in a similar manner. The extreme swings in voltage may be harmful to neural tissue, and care should be exercised in using this control.*

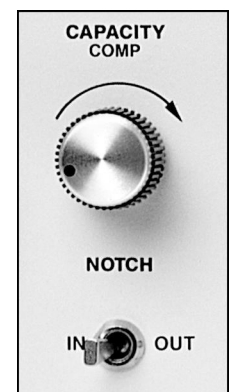

To accurately measure the impedance, verify at the **OUTPUT** connector that the signal is a pure 1.0 kHz sine wave, and that the sine wave is at its maximum amplitude (the point just before the signal becomes unstable).

NOTCH: This switch allows the Notch Filter to be included (**IN**) in the signal processing path or bypassed (**OUT**). *Warning: Although the Notch Filter provided can significantly reduce unwanted interference from the power source, it will cause some distortion of the signal, especially in frequencies below 100 Hz. Therefore, the Notch Filter should only be used if other noise reduction techniques such as proper grounding and shielding are inadequate.*

LOW CUT-OFF: This rotary switch enables the user to select the lower boundary frequency at which point the channel's input signal begins to be cut-off. Signals below the cut-off frequency will be attenuated by a factor of 100 (-40 dB) per decade decrease in the input signal frequency. For example, if the **LOW CUT-OFF** switch is set at **100 HZ**, then a 10 Hz signal will be attenuated by a factor of 100 while a 1 Hz signal will be attenuated by a factor of 10,000.

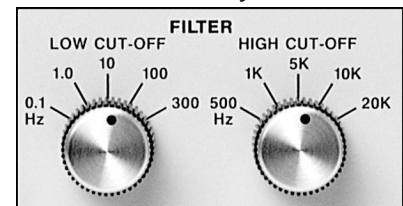

The Low Cut-Off frequency should be selected based on the frequency content of the signal to be recorded. One of the uses of this filter is to reduce slow variations or DC levels in the input signal.

HIGH CUT-OFF: This rotary switch enables the user to select the upper boundary frequency at which point the channel's input signal begins to be cut-off. Signals above the cut-off frequency will be attenuated by a factor of 100 (-40 dB) per decade increase in the input signal frequency. For example, if the **HIGH CUT-OFF** switch is set at **1 KHZ**, then a 10 kHz signal will be attenuated by a factor of 100 while a 100 kHz signal will be attenuated by a factor of 10 000. One of the uses of this filter is to reduce high frequency noise that is above the frequency content of the signal being recorded.

OUTPUT: This BNC connector provides the output signal from the amplifier channel.

GND: This connector on the front panel provides access to the circuit ground for its channel. Either the **PROBE GND** connector or the front panel **GND** must be connected for proper operation. Usually the **PROBE GND** connector is tied to the indifferent lead. If you desire to have the current constrained to a known path you may want to place the **GND** elsewhere. Actual **GND** placement depends on the application. For low-noise recordings a ground connection should be made in the recording medium (i.e. bath ground, animal ground, etc.).

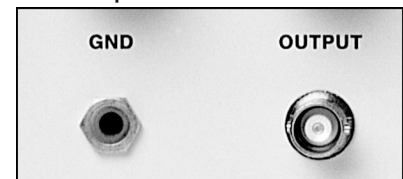

Operating Instructions

Typical Set-Up Procedure

The Head Stage Probe is used to connect the extracellular electrodes to the amplifier. The 4 inch Connector Cables can be used to connect the Probe inputs to electrodes which have standard gold male pin connectors. The **GND** connector on the front panel of the amplifier should be used as the system ground in the particular recording medium (e.g. bath or animal ground). *Note: Either the Head Stage **PROBE GND** or the **GND** on the front panel must be connected to provide a return current path. If neither ground is connected the Head Stage Amplifier will saturate and no signal will be measured.*

Care should be taken to keep the power cables from all instruments as far away as possible from the recording set-up. **Proper grounding and shielding techniques should be used to insure a minimum of interference.**

Recording

The **MODE** switch should be placed in the **REC** position. The **LOW CUT-OFF** Filter, **HIGH CUT-OFF** Filter, and **NOTCH** Filter should be set according to the frequency content of the signal to be recorded. The **GAIN** Switch should be set so that the signal at the **OUTPUT** connector is less than ± 10 V, otherwise higher and/or lower portions of the signal may appear cut-off or flattened.

Stimulating

When the **MODE** switch is placed in the **STIM** position, stimulation current (I) is monitored by measuring the voltage (V) across an internal, fixed resistor ($R = 1$ kV) in series with the electrodes. Since $I=V/R$ and R is known, the voltage is a measure of the stimulus current. The internal resistor is in series with the indifferent lead (**PROBE-**) so that excessive voltages do not appear at the Probe Amplifier inputs. Therefore, to ensure that the current in the indifferent lead is equal to and opposite of that in the active lead, only isolated stimulus sources should be used. The shield of the stimulation cable is not internally grounded in the amplifier and needs to be grounded at the connection to the stimulator. When an isolated stimulator is used the **PROBE-** connector must be grounded to function properly.

Checking Electrode Impedance

When the **MODE** switch is placed in the **IMP** position, the impedance the electrode can be checked. In this mode, an internal oscillator automatically passes a $0.1 \mu\text{A}$, 1 kHz sine-wave current (I) through the electrode, and the probe amplifier monitors the resultant voltage (V) that develops across the electrode. Since $R=V/I$ and I is known, the monitored voltage is a measure of the electrode impedance.

Theory of Operation

Overview

The Head Stage Probe, containing a high input impedance, low-noise, differential amplifier, is connected to the Model 1800 through a 9-pin Input connector assigned to each channel. The Mode Switch for each channel controls the input configuration of the Probe attached to that channel as well as the operation of the subsequent stages of the amplifier. In Record Mode, a combination of the Probe and the main circuit amplify the signal which appears across the two electrodes attached to the Probe. In Stimulus Mode, the signal at the Stimulus connector to be applied to the electrodes and the Probe monitors the stimulus current by measuring the voltage developed across a 1 k Ω resistor in series with the electrode. In Impedance Mode, an internally calibrated current is passed through the Probe to one electrode, and the Probe monitors electrode impedance by measuring the voltage that develops across the two electrodes.

The signal from the Probe passes through the differential amplifier which has a unity gain in Record and Stimulus Modes and a gain of x0.01 in Impedance Mode. The signal then passes through the Low Cut-Off Filter and is increased by a factor of 10. Next the signal enters the Notch Filter if it is activated. Finally the signal passes through the High Cut-Off Filter which has a unity gain in Stimulus and Impedance Modes and an adjustable gain controlled by the Gain Switch while in Record Mode

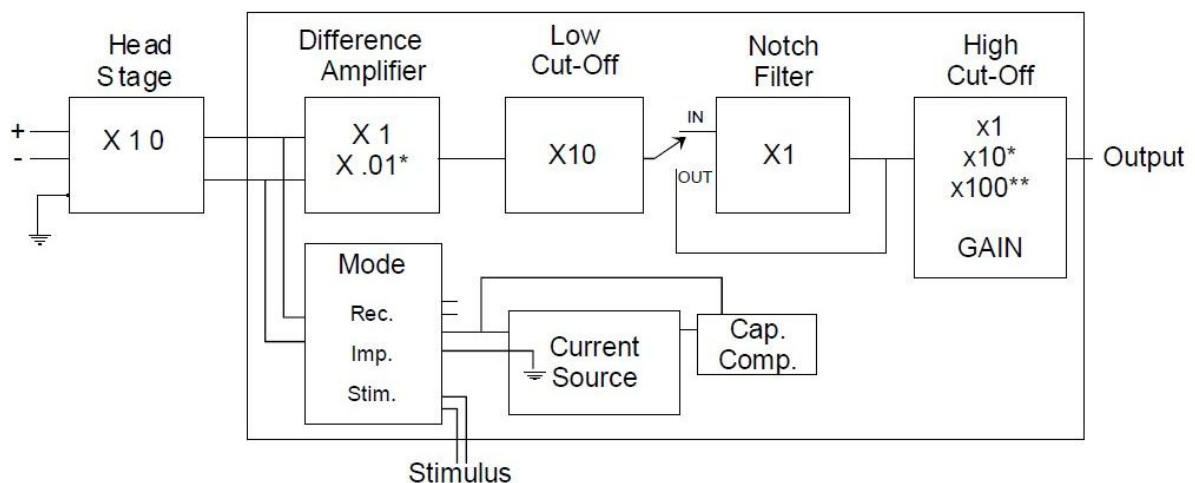

Figure 2. Main circuit description and block diagram

*Only for impedance mode

**Only for record mode

Operational Modes

Record Mode

In Record Mode, the inputs of the Probe amplifier are switched by a relay, connecting them differentially across the two electrodes in order to amplify with a x10 gain the neural activity appearing at the electrode-tissue interface. In this mode the Stimulus relay is off so that the Stimulus leads do not feed noise

into the circuit. The differential output signal passes through the differential amplifier, the Low Frequency Cut-Off Filter, and the Notch Filter if activated, in that order. Finally the signal passes through the High Frequency Cut-Off Filter, whose gain selection circuit is enabled by the gain switch.

Head stage circuitry in Record Mode

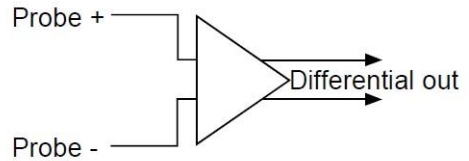

Stimulus Mode

In Stimulus Mode, the differential inputs of the Probe amplifier are switched so that they are across a 1 kΩ resistor that is in series with **PROBE-**, the indifferent electrode lead. At the same time, the stimulus source at the **STIMULUS** connector is connected to the electrode leads. A stimulus current from an isolated source passes through the **PROBE+** lead to the active electrode, returning through the **PROBE-** lead and the 1 kΩ resistor. The current creates a voltage across the resistor which is amplified by the Probe amplifier and passes through the differential amplifier.

Head stage circuitry in Stimulus Mode

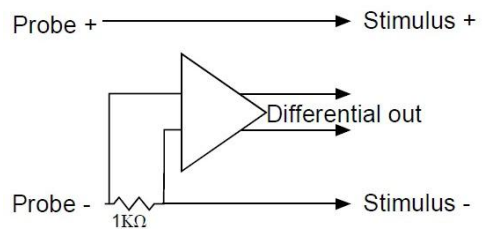

Impedance Mode

In Impedance Mode, the differential inputs of the Probe amplifier are switched across the two electrode leads. At the same time an internal current source is connected to the electrode leads. The current source generates a 0.1 mA, 1 kHz sine wave that passes through the electrodes, and the voltage that develops is a measure of the electrode impedance.

Head stage circuitry in Impedance Mode

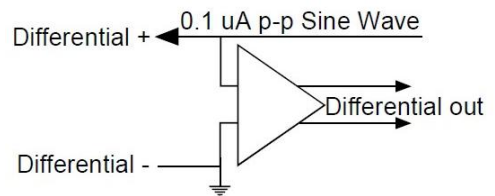

Specifications

Record Mode

Gain settings available	(x100, x1000 or x10 000) \pm 5%
Noise	3 μ V rms (10Hz to 10kHz)

Stimulus Mode

Output current ratio	0.1 V/ 1 μ A
Maximum output current reading	\pm 10 V or \pm 100 μ A
Maximum stimulus current	10 mA
Maximum stimulus voltage	
Pin A (+ diff) upper left pin hole	\pm 100V
Pin B (-diff) upper right pin hole	\pm 15V

Impedance Input

Output impedance ratio	1 M Ω / 0.1 V
Maximum output impedance reading	4 V or 40 M Ω

General Electrical

Input impedance	100 000 M Ω , typical
Output Impedance	< 1 Ω
Common mode rejection	Adjustable to better than -80 dB
Notch Filter	Better than -30 dB at 60 Hz; Better than -25 dB at 50 Hz
Input bias current	200 pA, typical
DC Compliance range	At least \pm 1 V DC
Output dynamic range	\pm 10 V AC, minimum
Low cut-off frequency settings	0.1 Hz, 1 Hz, 10 Hz, 100 Hz, 300 Hz \pm 15%
Low cut-off filter gain	-40 dB / decade
High cut-off frequency settings	0.5kHz, 1kHz, 5kHz, 10kHz, 20kHz, \pm 15%
High cut-off filter gain	-40 dB / decade
Power	115 V, 60 Hz or 230 V, 50 Hz; < 5 W total

Physical Dimensions

Width	17 inches (43.2 cm)
Height	4.75 inches (12.1 cm)

Warranty and Service

LIMITED WARRANTY

What does this warranty cover?

A-M Systems, LLC (hereinafter, “A-M Systems”) warrants to the Purchaser that the Instruments manufactured by A-M Systems (hereinafter the “hardware”), and sold after January 1, 2020, is free from defects in workmanship or material under normal use and service for the lifetime of the hardware. Headstages manufactured by A-M Systems and sold after January 1, 2020, will be repaired under warranty only once per year. This warranty commences on the date of delivery of the hardware to the Purchaser. “Lifetime” is defined as the time all components in the instrument can still be purchased from mainstream, common, electronic component distributors such as Digi-Key Electronics, Newark, or Mouser Electronics.

For hardware sold prior to January 1, 2020, the warranty in effect at time of purchase applies, with the maximum warranty period of three (3) years for new purchases, and one (1) year for those that have been repaired by A-M Systems. For headstages manufactured by A-M Systems and sold prior to January 1, 2020, the maximum warranty period is one (1) year.

What are the obligations of A-M Systems under this warranty?

During the warranty period, A-M Systems agrees to repair or replace, at its sole option, without charge to the Purchaser, any defective component part of the hardware. To obtain warranty service, the Purchaser must return the hardware to A-M Systems or an authorized A-M Systems distributor in an adequate shipping container. Any postage, shipping and insurance charges incurred in shipping the hardware to A-M Systems must be prepaid by the Purchaser, and all risk for the hardware shall remain with Purchaser until A-M Systems takes receipt of the hardware. Upon receipt, A-M Systems will promptly repair or replace the defective unit and then return the hardware (or its replacement) to the Purchaser with postage, shipping, and insurance prepaid by the Purchaser. A-M Systems may use reconditioned or like-new parts or units at its sole option, when repairing any hardware. Repaired products shall carry the same amount of outstanding warranty as from original purchase. Any claim under the warranty must include a dated proof of purchase of the hardware covered by this warranty. In any event, A-M Systems liability for defective hardware is limited to repairing or replacing the hardware.

What is not covered by this warranty?

This warranty is contingent upon proper use and maintenance of the hardware by the Purchaser and does not cover batteries. Neglect, misuse whether intentional or otherwise, tampering with or altering the hardware, damage caused

LIMITED WARRANTY, cont

by accident, damage caused by unusual physical, electrical, chemical, or electromechanical stress, damage caused by failure of electrical power, or damage caused during transportation are not covered by this warranty. Further, no guarantee is made regarding software compatibility with future updated operating systems. Products may not be returned to A-M Systems for service, whether under warranty or otherwise, which are contaminated by infectious agents, radioactive compounds or other materials constituting a health hazard to employees of A-M Systems

What are the limits of liability for A-M Systems under this warranty?

A-M Systems shall not be liable for loss of data, lost profits or savings, or any special, incidental, consequential, indirect or other similar damages, whether arising from breach of contract, negligence, or other legal action, even if the company or its agent has been advised of the possibility of such damages, or for any claim brought against you by another party.

THIS EQUIPMENT IS NOT INTENDED FOR CLINICAL MEASUREMENTS USING HUMAN SUBJECTS.

A-M SYSTEMS DOES NOT ASSUME RESPONSIBILITY FOR INJURY OR DAMAGE DUE TO MISUSE OF
THIS EQUIPMENT.

Jurisdictions vary with regard to the enforceability of provisions excluding or limiting liability for incidental or consequential damages. Check the provision of your local jurisdiction to find out whether the above exclusion applies to you.

This warranty allocates risks of product failure between the Purchaser and A-M Systems. A-M Systems hardware pricing reflects this allocation of risk and the limitations of liability contained in this warranty. The agents, employees, distributors, and dealers of A-M Systems are not authorized to make modifications to this warranty, or additional warranties binding on the company. Accordingly, additional statements such as dealer advertising or presentations, whether oral or written, do not constitute warranties by A-M Systems and should not be relied upon. This warranty gives you specific legal rights. You may also have other rights which vary from one jurisdiction to another.

THE WARRANTY AND REMEDY PROVIDED ABOVE IS IN LIEU OF ALL OTHER WARRANTIES AND REMEDIES, WHETHER EXPRESS OR IMPLIED. A-M SYSTEMS DISCLAIMS THE WARRANTIES OF MERCHANTABILITY AND FITNESS FOR A PARTICULAR USE, WITHOUT LIMITATION.

Revision History

Rev	Date	Description
7	6/30/06	Initial Document Control release
8	4/28/10	DCR201200 Warranty and Company Information
9	2/10/16	DCR 202464. Remove Calibration information
12	1/18/19	DCR 202615. Review content. Add rev control to content.
13	3/19/20	DCR 203316. Update warranty